

Capillary Ultrafiltration Module

HYDRAcap[®] MAX 40

Performance¹	Filtrate Flow: Filtrate Turbidity: Bacteria removal:	7.5 –24.4 gpm (1.7 – 5.5 m ³ /h) ≤ 0.10 NTU ≥ 4 log
Type	Configuration: Membrane Polymer: Nominal Membrane Area: Fiber Dimensions: Pore size:	Capillary Ultrafiltration Module PVDF 560 ft ² (52 m ²) ID 0.024" (0.6 mm), OD 0.047" (1.2 mm) 0.08 micron
Application Data²	Typical Filtrate Flux Range: Maximum Applied Feed Pressure: Maximum Transmembrane Pressure: Instantaneous Chlorine Tolerance: Maximum Chlorine Exposure: Maximum Feed Turbidity: Maximum Operating Temperature: pH Operating Range: Cleaning pH Range: Operating Mode:	20 – 65 gfd (34 – 110 l/m ² /h) 73 psig (5.0 bar) ³ 30 psig (2.0 bar) 5000 ppm ⁴ 750,000 ppm-hrs 300 NTU ⁵ 104 °F (40 °C) 4.0 – 10.0 1.0 – 13.0 Outside to Inside Filtration Dead End or Cross flow mode

Typical Process Conditions

Air Scour Rate:	7.3 – 9.1 acfm (12.3 – 15.4 m ³ /h)
Air Scour Duration:	120 – 240 seconds
Air Scour Frequency:	Once every 20 – 60 minutes
Maintenance Clean Frequency:	1 – 3 times per day
Maintenance Clean Duration:	20 – 30 minutes
Disinfection Chemicals:	NaOCl, ClO ₂ or NH ₂ Cl
Cleaning Chemicals:	NaOH, HCl, H ₂ SO ₄ or Citric Acid

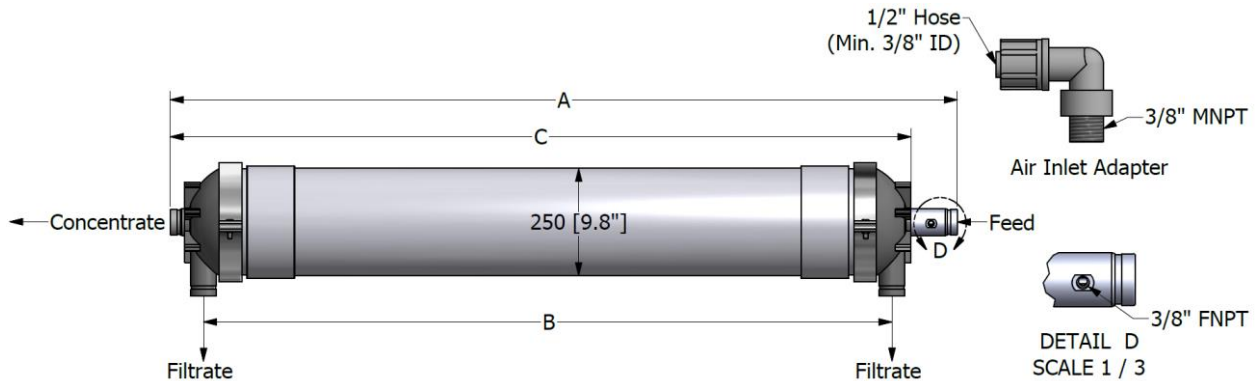

A, inches (mm)	B, inches (mm)	C, inches (mm)	Pipe connections	Dry Weight	Wet Weight
53.74 (1364.9)	44.70 (1135.5)	49.50 (1257.3)	2" Victaulic	90 lbs (41 kg)	161 lbs (73 kg)

Certifications: NSF61, NSF419 (US LT2ESWTR – Public Drinking Water Compliance)

¹ Typical module performance for most feedwaters.

² The limitations shown here are for general use. The values may be more conservative for specific projects to ensure the best performance and longest life of the membrane.

³ At 68°F (20°C). 58psi (4 bar) @ 86°F (30°C). 44 psi (3 bar) @ 104°F (40°C).

⁴ For 60 minutes or less.

⁵ Higher values can be treated. Consult Hydranautics' technical staff.



Notice: Hydranautics also offers HYDRAcap[®] MAX 40-NON, which is a dummy module with no potting or fiber.

Hydranautics believes the information and data contained herein to be accurate and useful. The information and data are offered in good faith, but without guarantee, as conditions and methods of use of our products are beyond our control. Hydranautics assumes no liability for results obtained or damages incurred through the application of the presented information and data. It is the user's responsibility to determine the appropriateness of Hydranautics' products for the user's specific end uses.

3/25/16